

# ZWEIRADGARAGE S - B - 140

SOCKELBODEN 100 / 140 cm

VOLUMEN CA. 1750 L

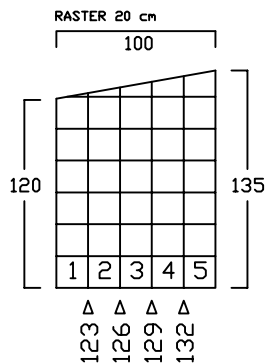

INNENMASS

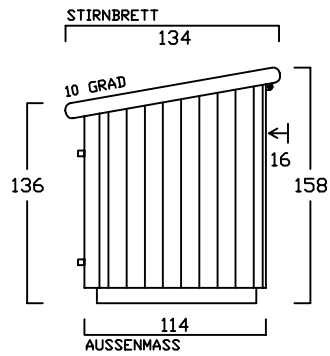

GESCHLOSSEN

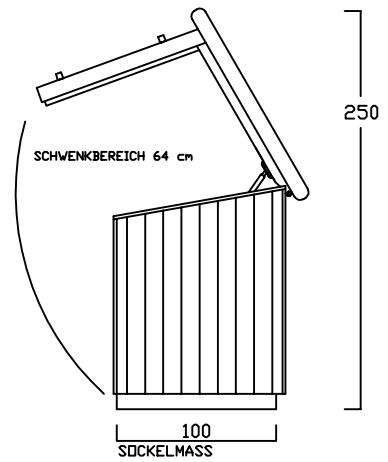

OFFEN

