

ZWEIRADGARAGE S - B - 160

SOCKELBODEN 100 / 160 cm

VOLUMEN CA. 2000 L

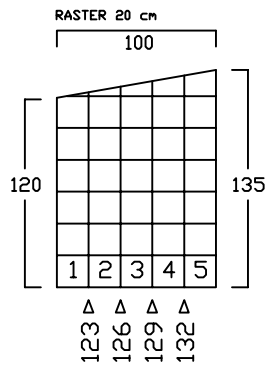

INNENMASS

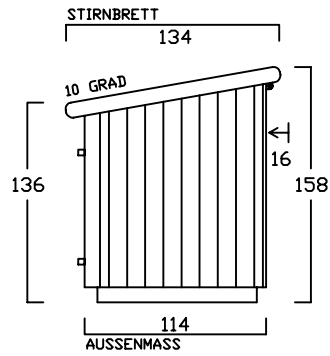

GESCHLOSSEN

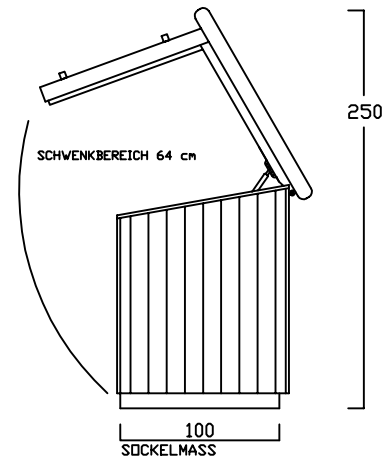

OFFEN

