

ZWEIRADGARAGE S - B - 200

SOCKELBODEN 100 / 200 cm

VOLUMEN CA. 2500 L

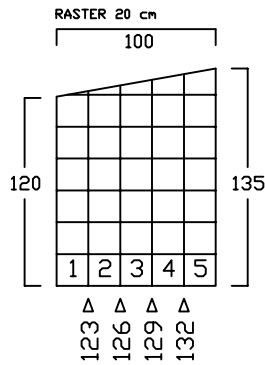

INNENMASS

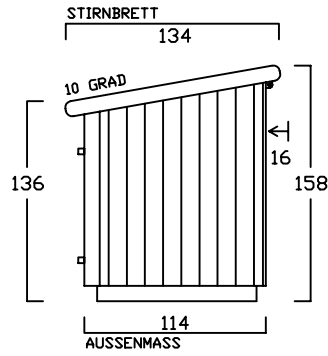

GESCHLOSSEN

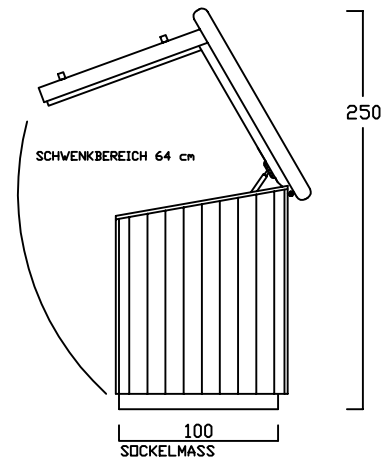

OFFEN

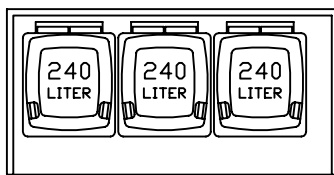
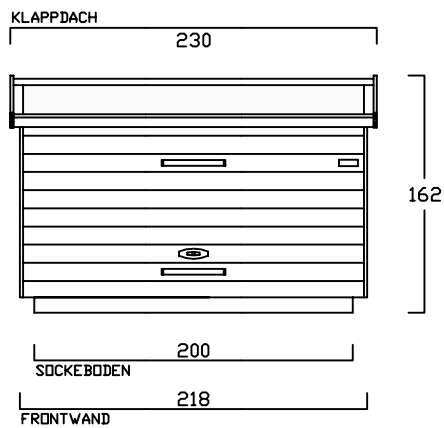

INNENRAUM

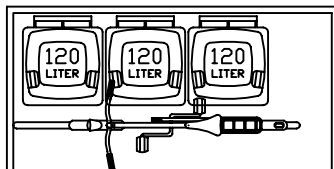

INNENRAUM

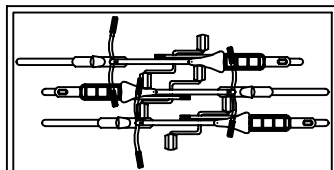

INNENRAUM