

ZWEIRADGARAGE S - C - 160

SOCKELBODEN 120 / 160 cm

VOLUMEN CA. 2450 L

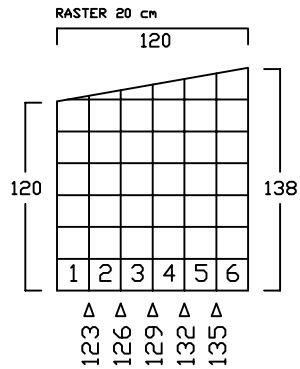

INNENMASS

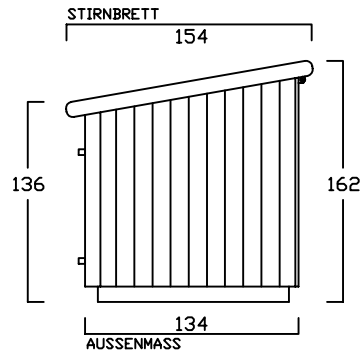

GESCHLOSSEN

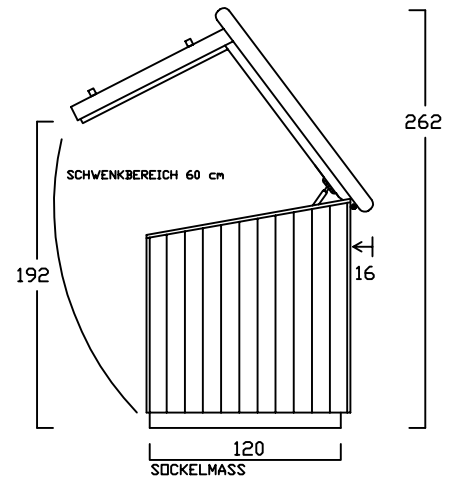

OFFEN

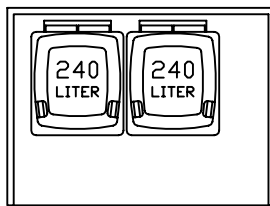
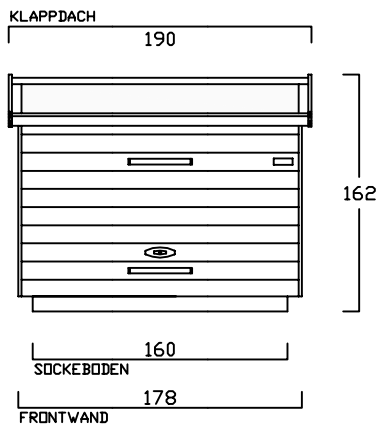

INNENRAUM