

ZWEIRADGARAGE S - C - 180

SOCKELBODEN 120 / 180 cm

VOLUMEN CA. 2750 L

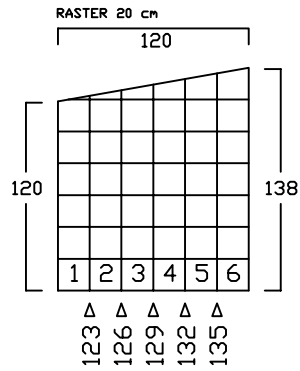

INNENMASS

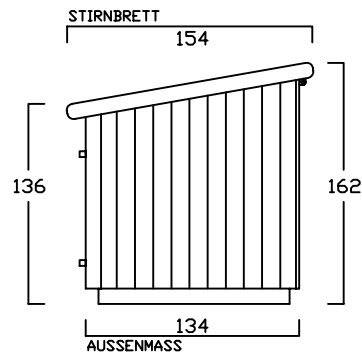

GESCHLOSSEN

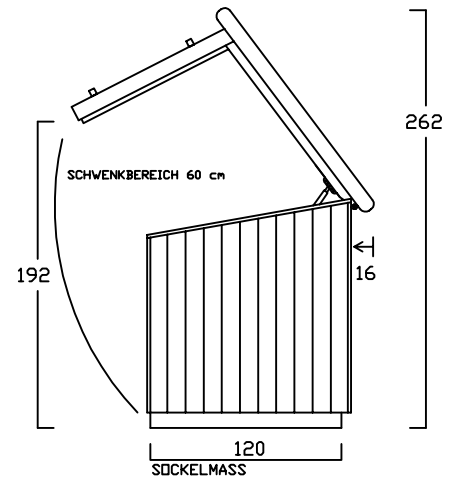

OFFEN

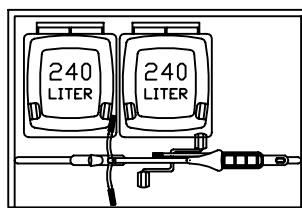
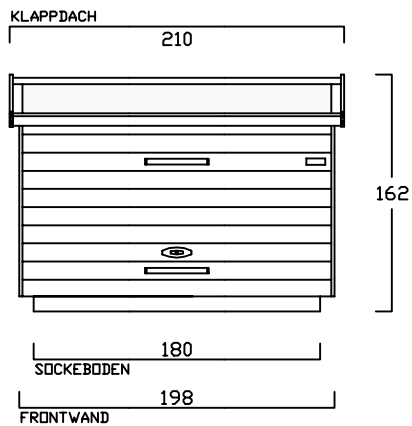

INNENRAUM