

# SICHTSCHUTZWÄNDE

120 LITER MÜLLTONNE

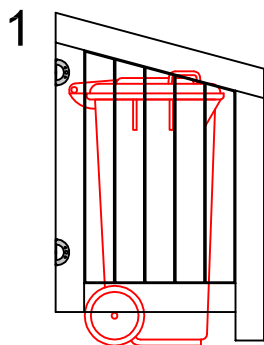

SSW 15 GRAD 70/110

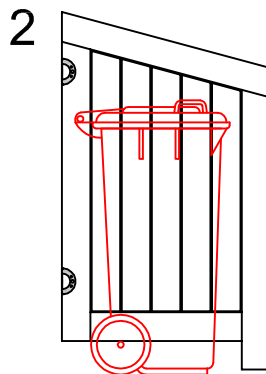

SSW 15 GRAD 70/120

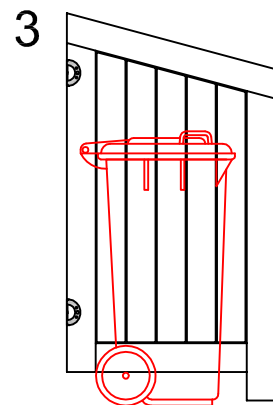

SSW 15 GRAD 70/130

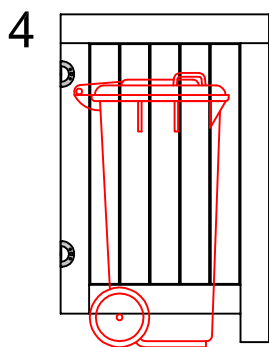

SSW 90 GRAD 70/110

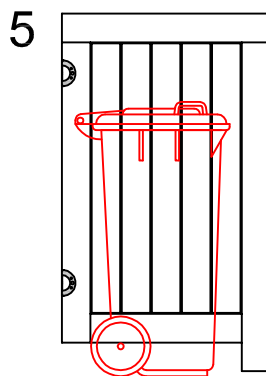

SSW 90 GRAD 70/120

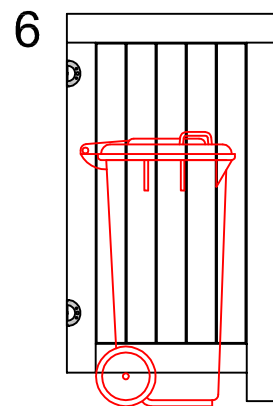

SSW 90 GRAD 70/130

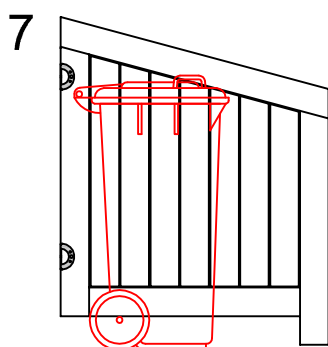

SSW 15 GRAD 90/110

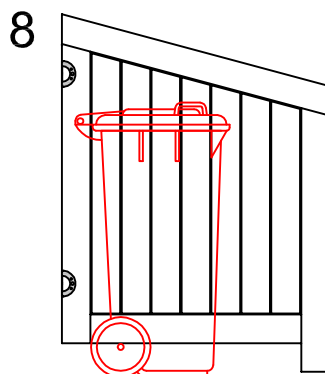

SSW 15 GRAD 90/120

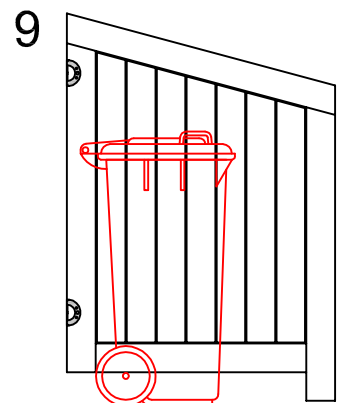

SSW 15 GRAD 90/130

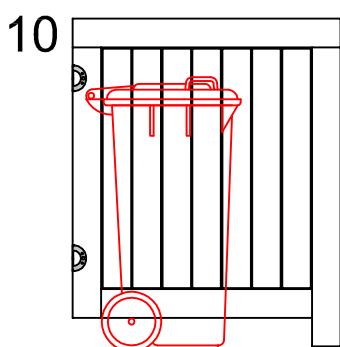

SSW 90 GRAD 90/110

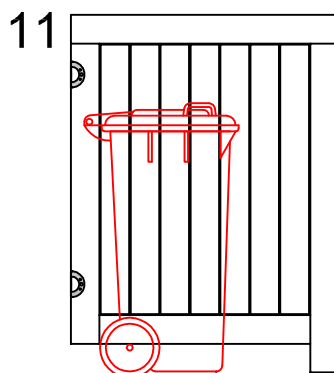

SSW 90 GRAD 90/120

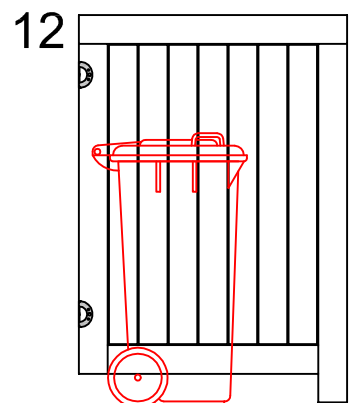

SSW 90 GRAD 90/130

# SICHTSCHUTZWÄNDE (SSW) FÜR MÜLLTONNEN

## ZG - A -

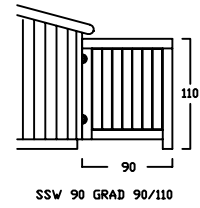
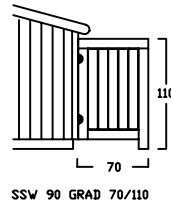
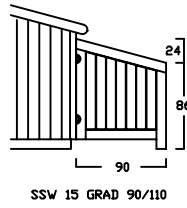
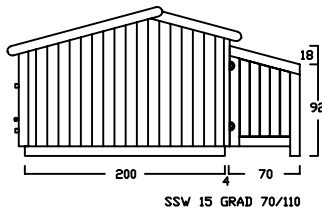

## ZG - B -

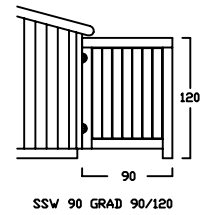
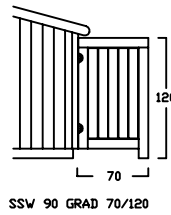
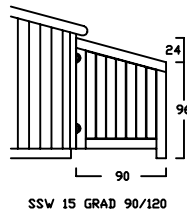
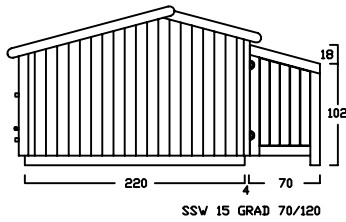

## ZG - C -

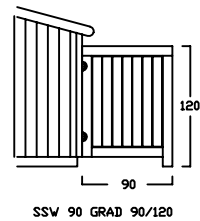
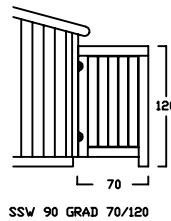
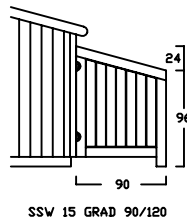
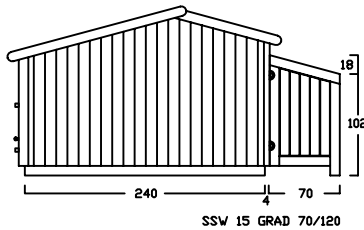

## ZG - D -

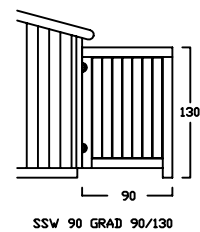
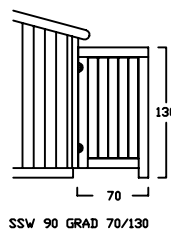
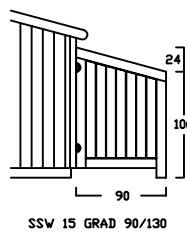
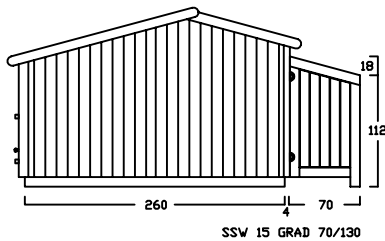

## ZG - E -

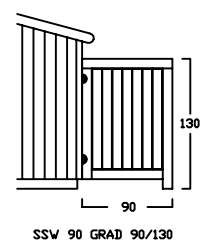
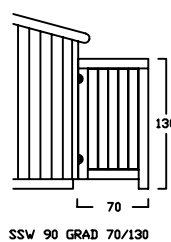
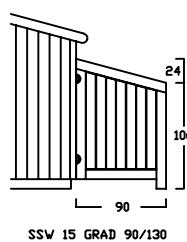
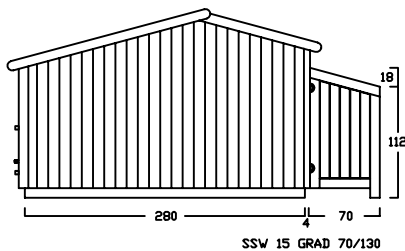

## ZG - F -

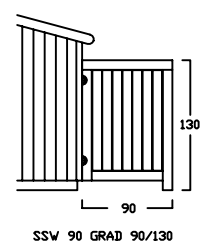
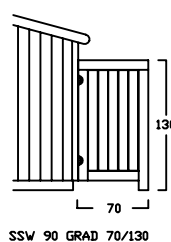
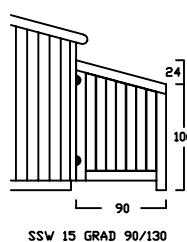
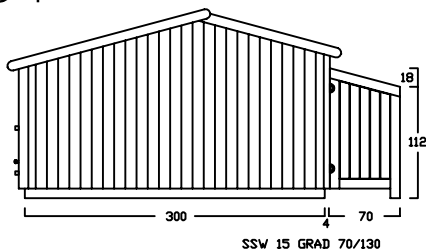

# SICHTSCHUTZWÄNDE (SSW) FÜR MÜLLTONNEN

## ZG - A -

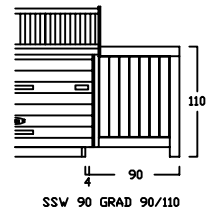
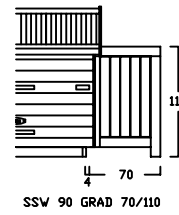
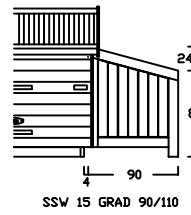
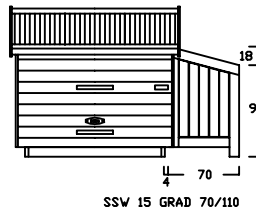
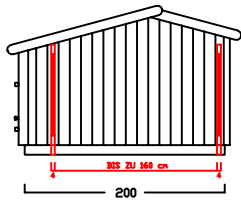

## ZG - B -

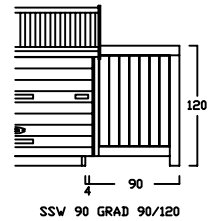
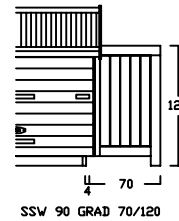
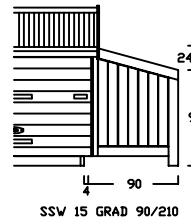
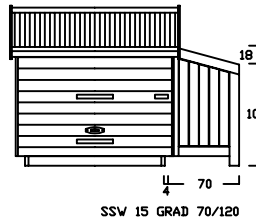
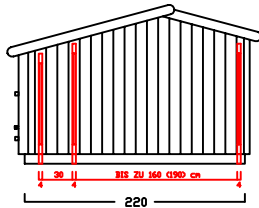

## ZG - C -

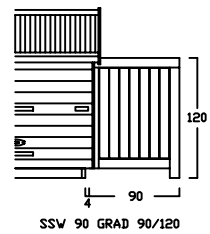
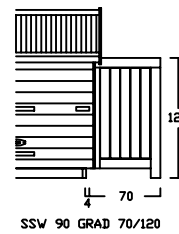
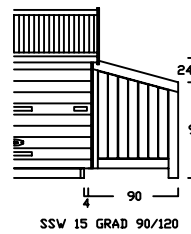
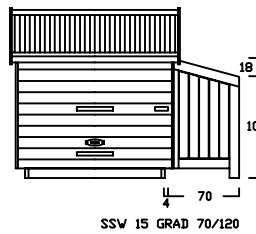
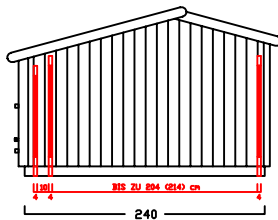

## ZG - D -

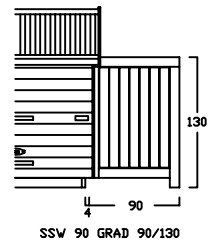
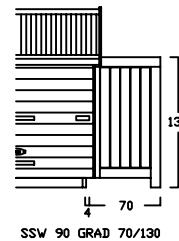
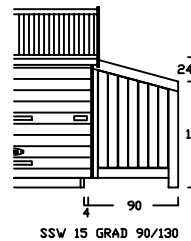
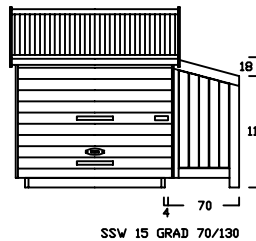
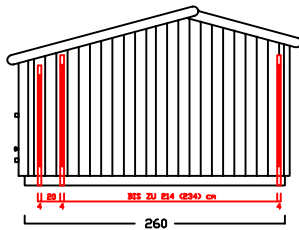

## ZG - E -

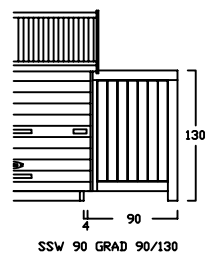
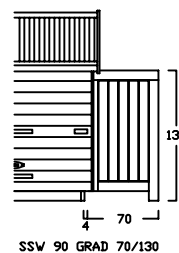
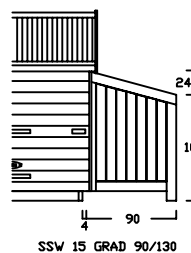
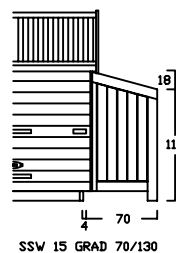
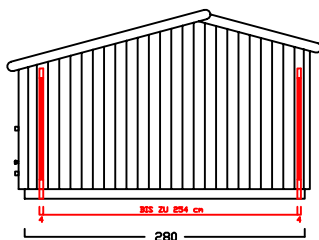

## ZG - F -

