

# ZWEIRADGARAGE IN 36 GRÖSSEN

## ZG - A -

INNENBREITE:  
100-120-140-160-180-200

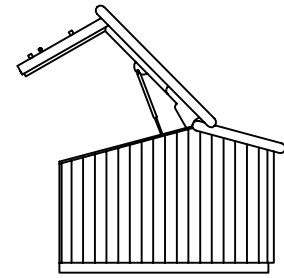
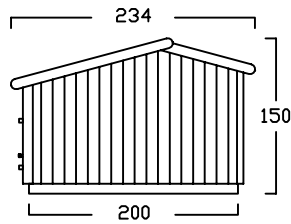

## ZG - B -

INNENBREITE:  
100-120-140-160-180-200

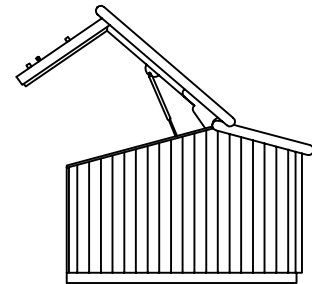
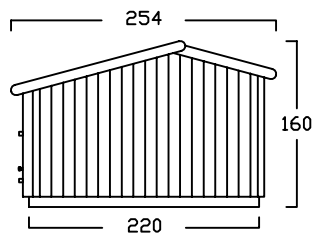

## ZG - C -

INNENBREITE:  
100-120-140-160-180-200

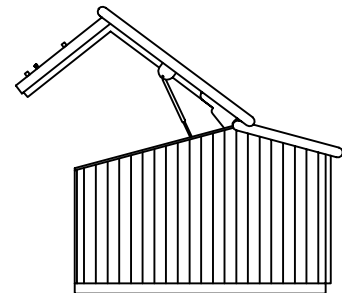
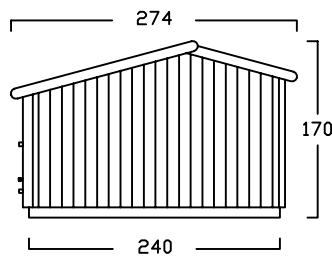
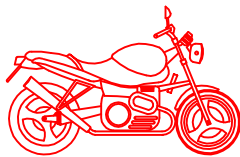

## ZG - D -

INNENBREITE:  
100-120-140-160-180-200

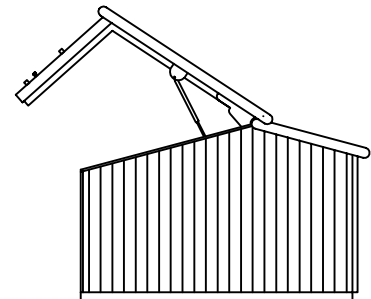
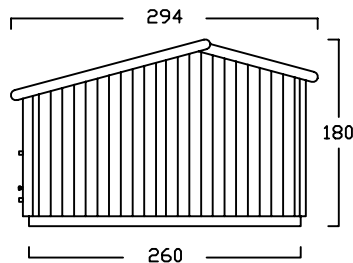
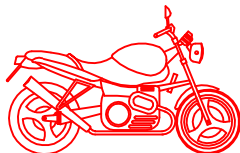

## ZG - E -

INNENBREITE:  
100-120-140-160-180-200

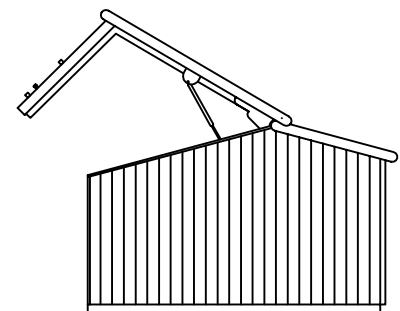
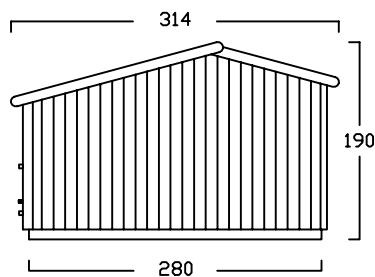
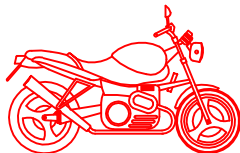

## ZG - F -

INNENBREITE:  
100-120-140-160-180-200

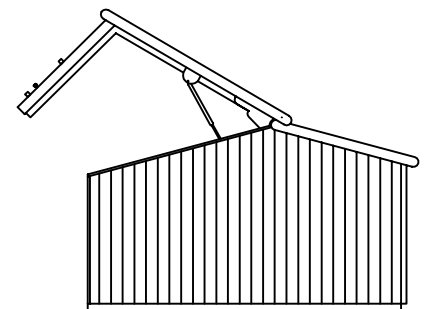
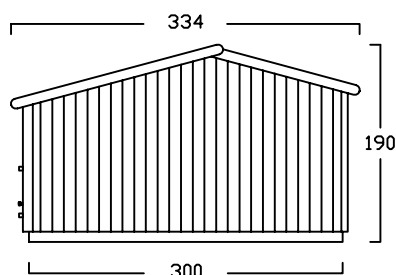
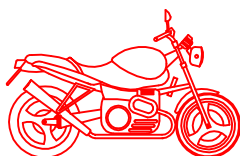

# ZWEIRADGARAGE TYP - A -

INNENMASS RASTER 20 cm

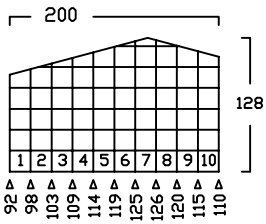

15 GRAD DACHNEIGUNG

FAHRRAD MIT  
LENKERHÖHE 110 cm

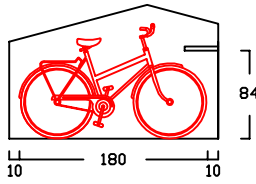

FAHRRAD MIT  
LENKERHÖHE 110 cm

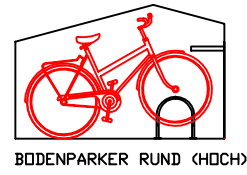

BODENPARKER RUND (HOCH)

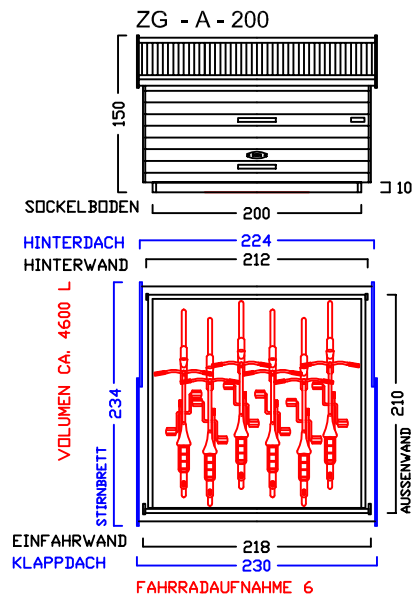
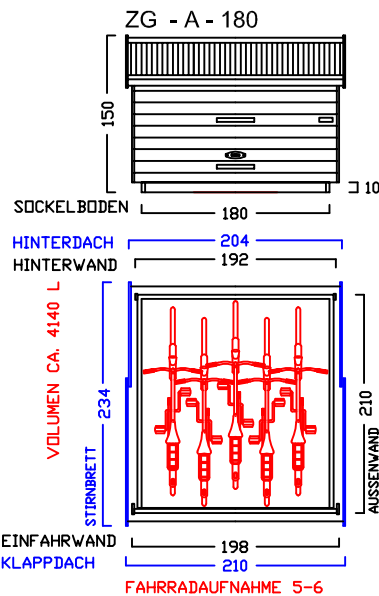
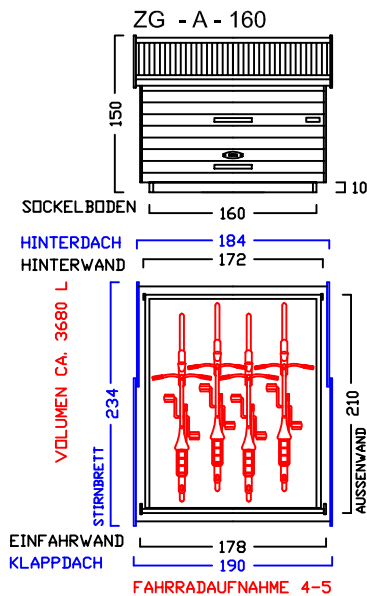
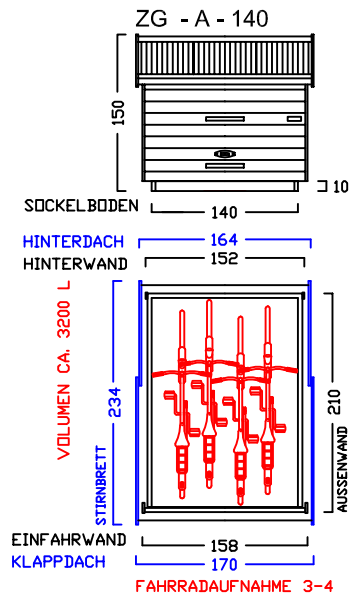
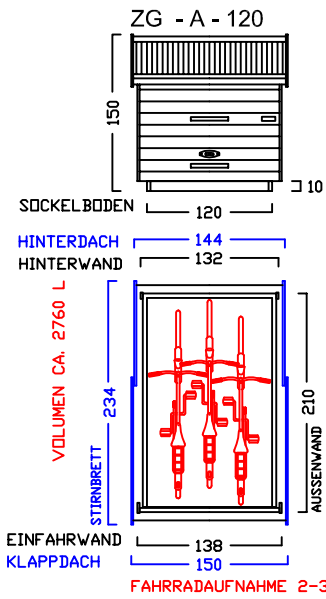
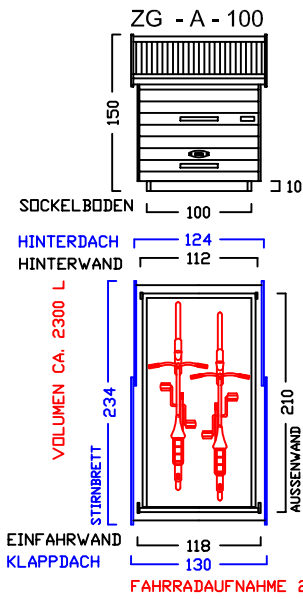
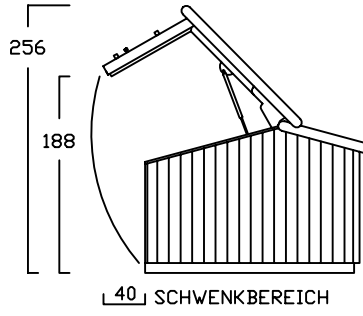
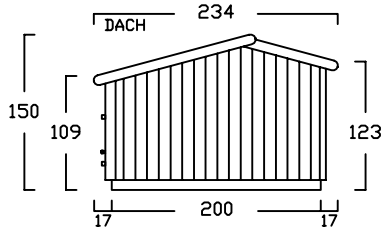

# ZWEIRADGARAGE TYP - B -

INNENMASS RASTER 20 cm

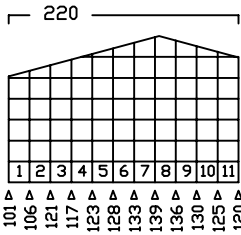

15 GRAD DACHNEIGUNG

FAHRRAD MIT LENKERHÖHE 110 cm

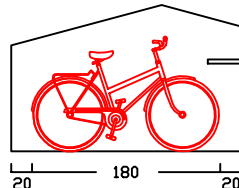

FAHRRAD MIT LENKERHÖHE 110 cm

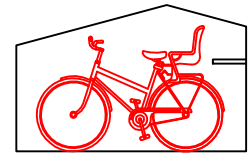
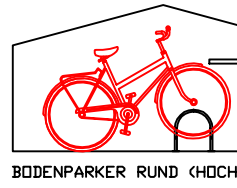

BODENPARKER RUND (HOCH)

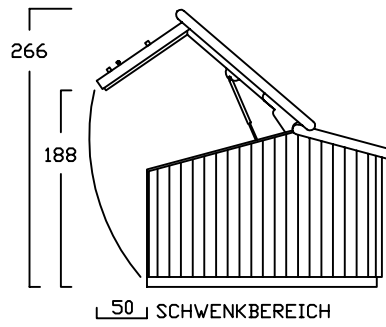
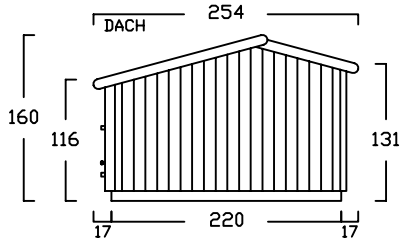

ZG - B - 100

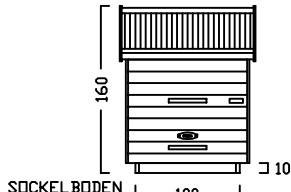

HINTERDACH 124  
HINTERWAND 112

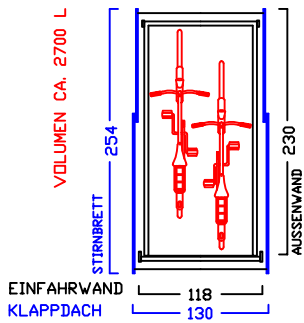

FAHRRADAUFNAHME 2

ZG - B - 120

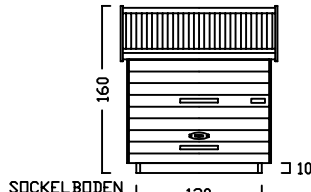

HINTERDACH 144  
HINTERWAND 132

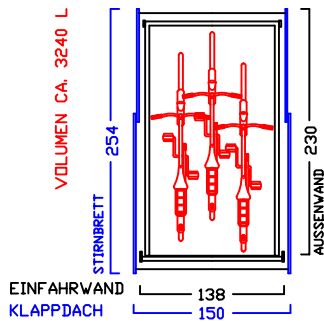

FAHRRADAUFNAHME 2-3

ZG - B - 140

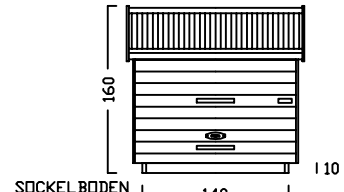

HINTERDACH 164  
HINTERWAND 152

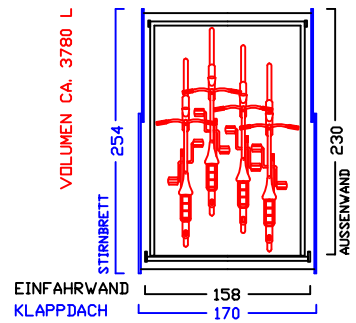

FAHRRADAUFNAHME 3-4

ZG - B - 160

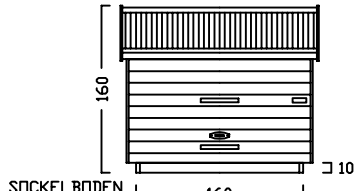

HINTERDACH 184  
HINTERWAND 172

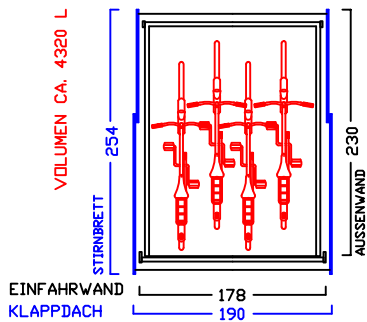

FAHRRADAUFNAHME 4-5

ZG - B - 180

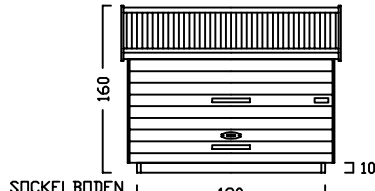

HINTERDACH 204  
HINTERWAND 192

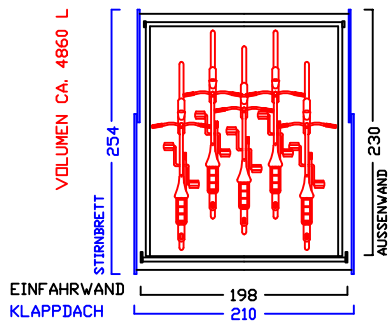

FAHRRADAUFNAHME 5-6

ZG - B - 200

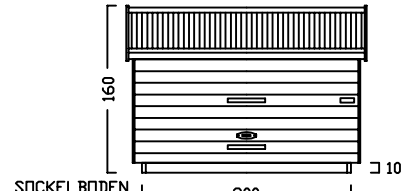

HINTERDACH 224  
HINTERWAND 212

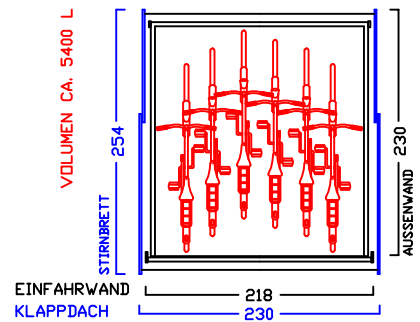

FAHRRADAUFNAHME 6

# ZWEIRADGARAGE TYP - C -

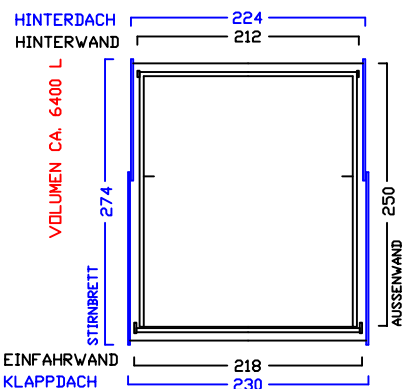
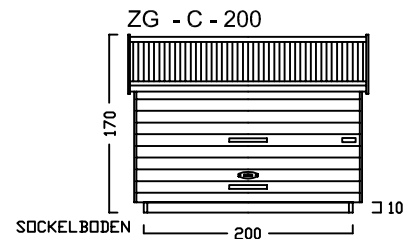
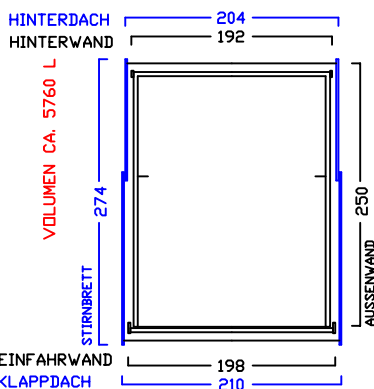
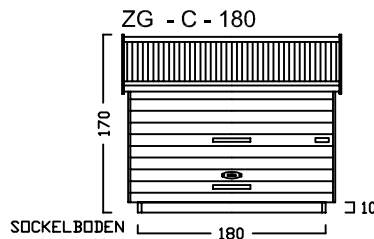
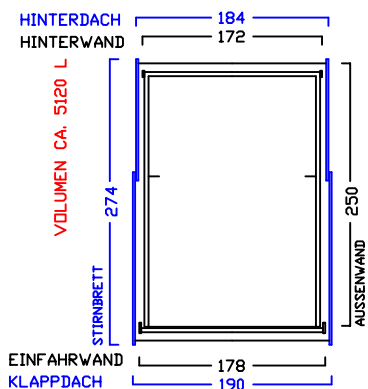
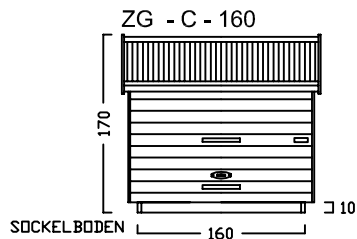
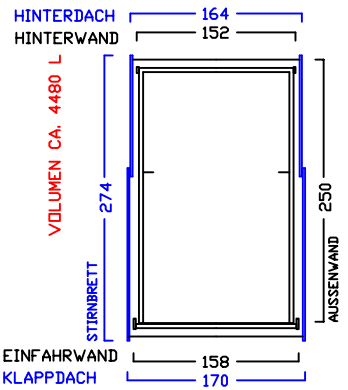
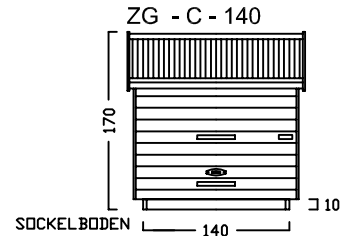
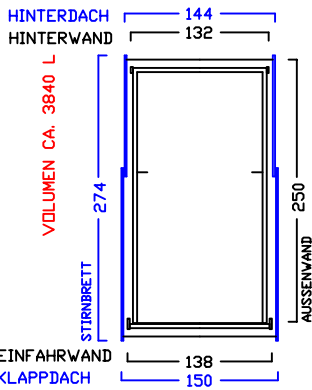
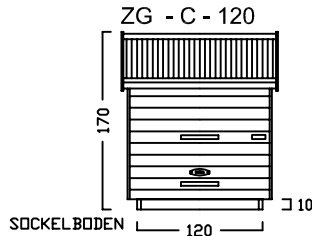
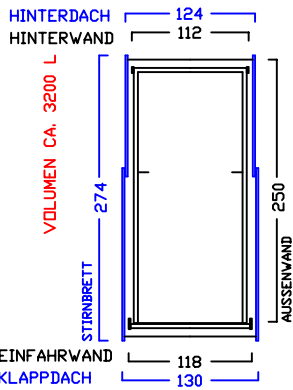
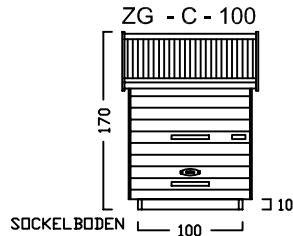
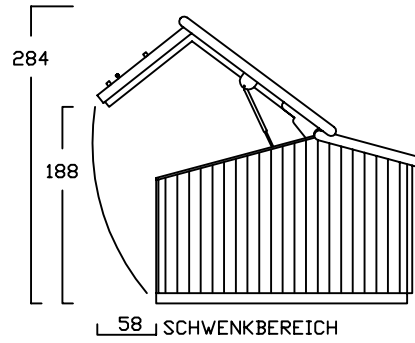
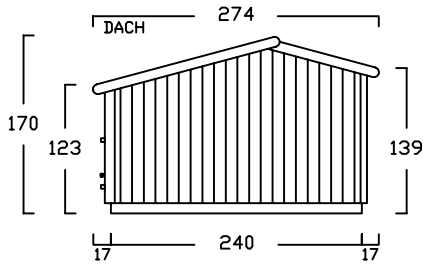
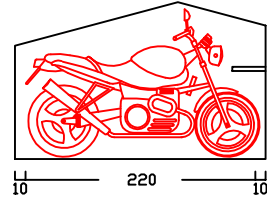
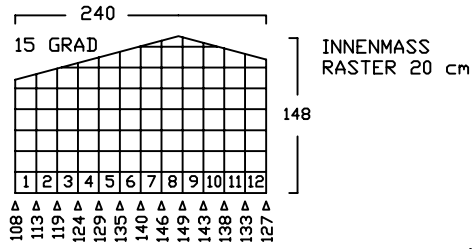

# ZWEIRADGARAGE TYP - D -

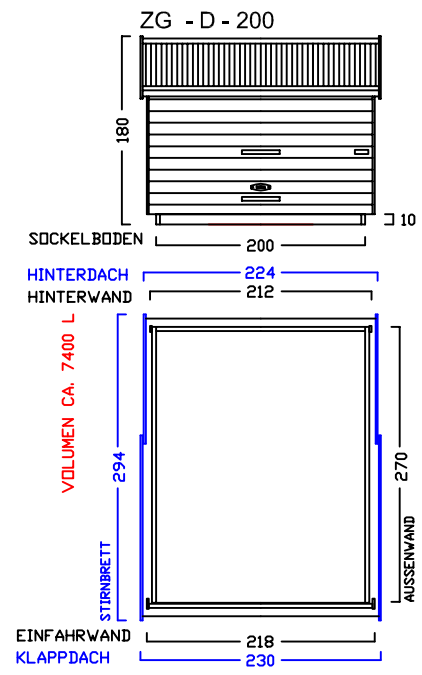
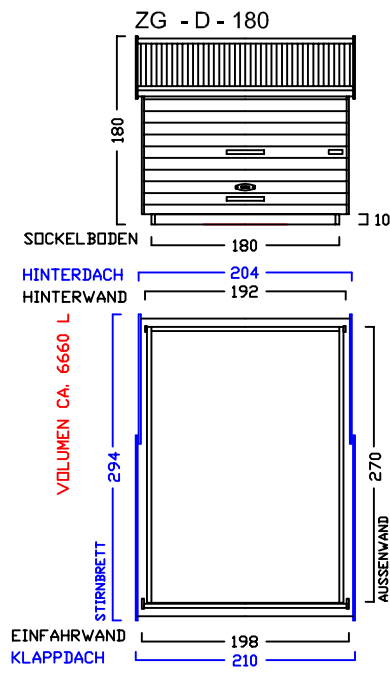
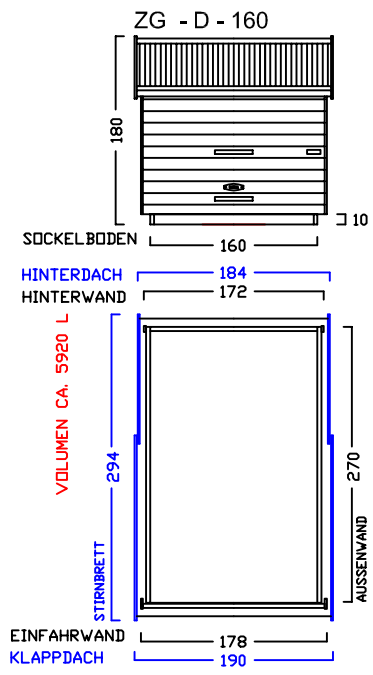
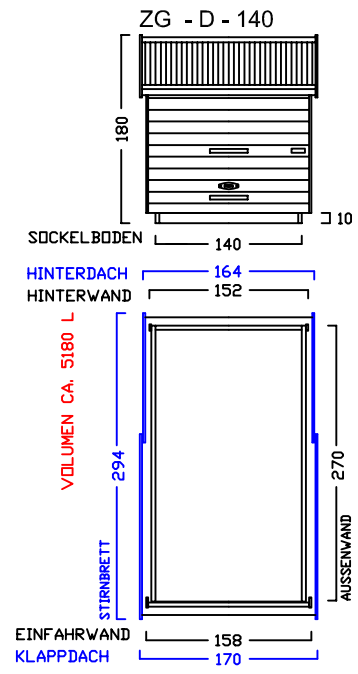
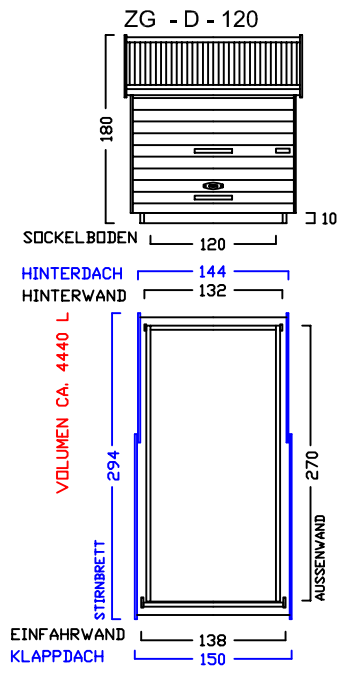
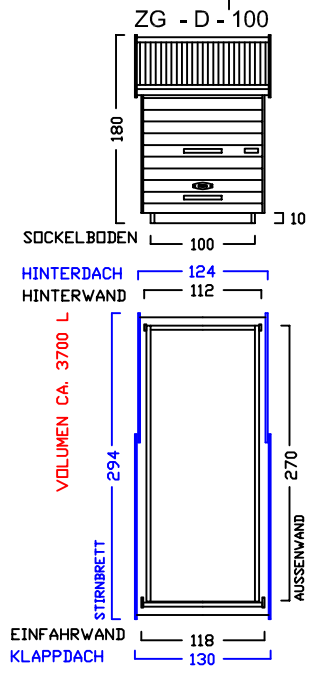
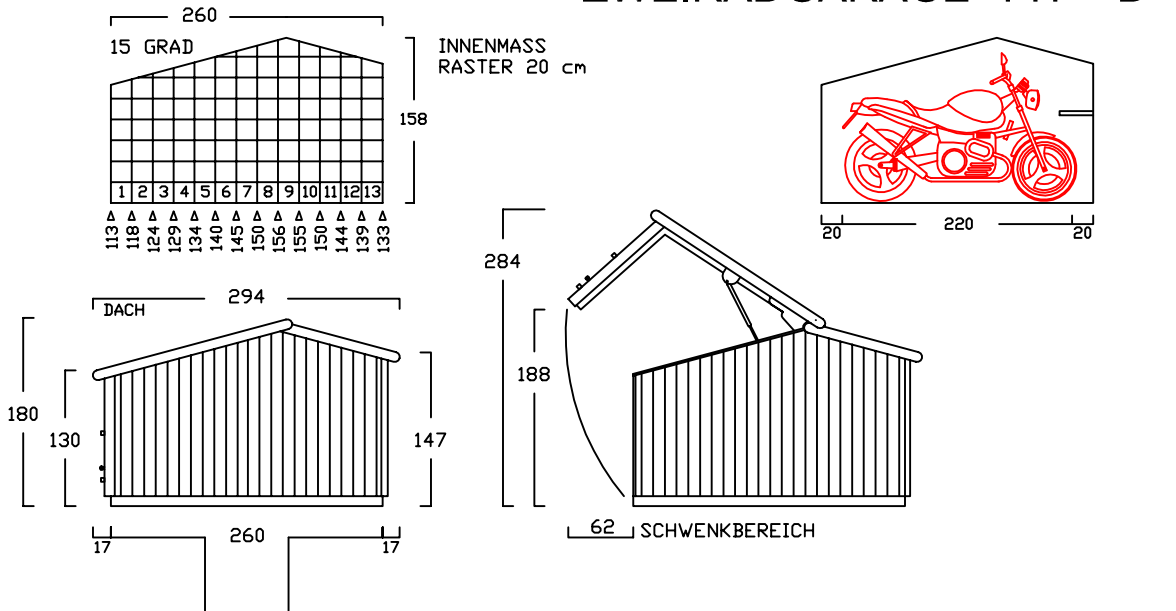

# ZWEIRADGARAGE TYP - E -

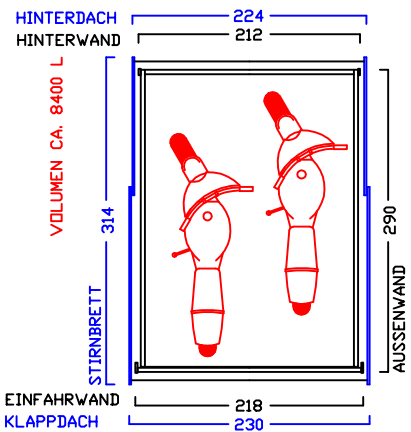
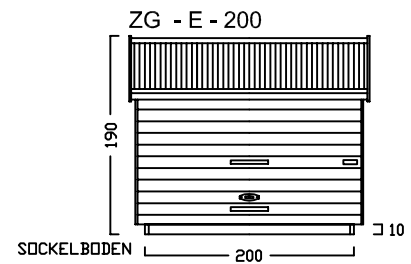
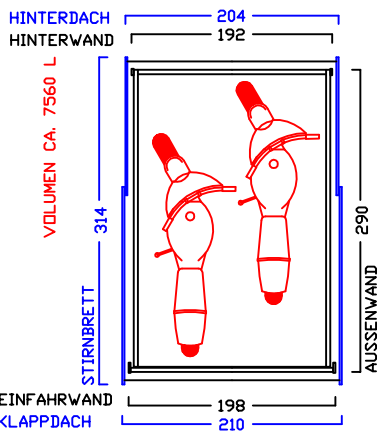
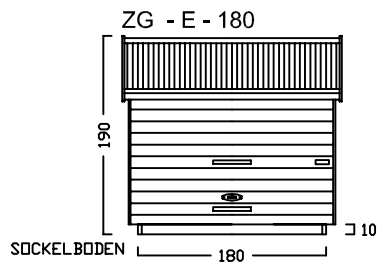
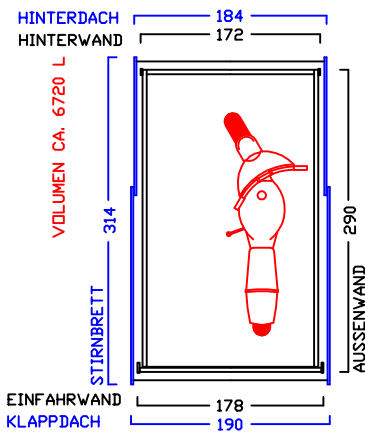
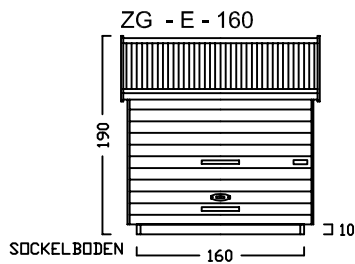
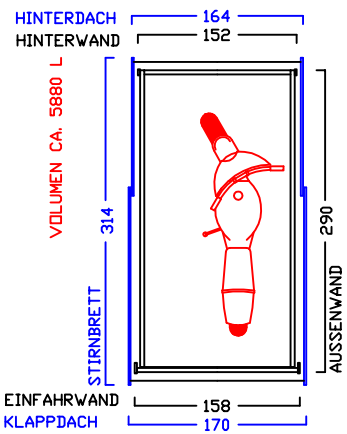
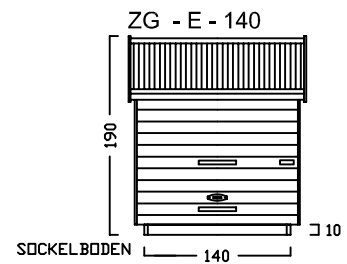
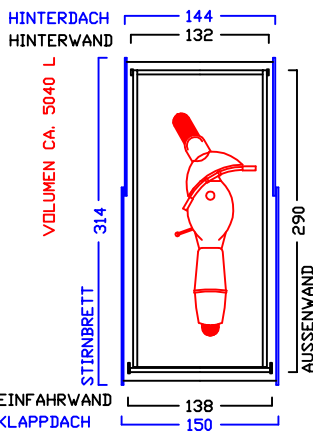
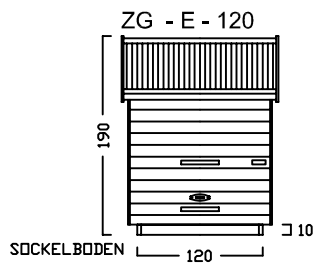
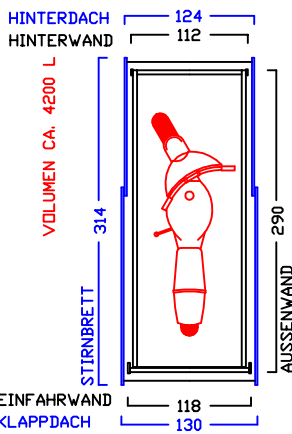
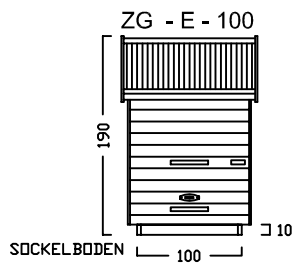
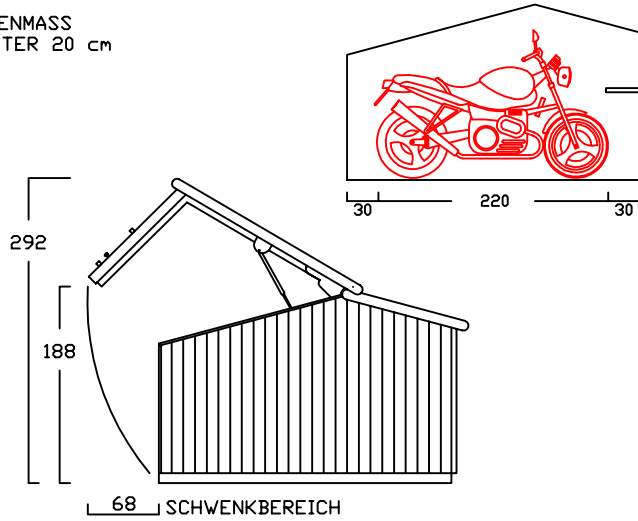
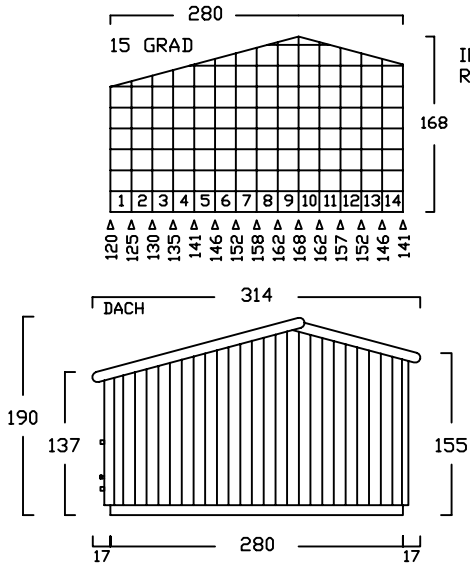

# ZWEIRADGARAGE TYP - F -

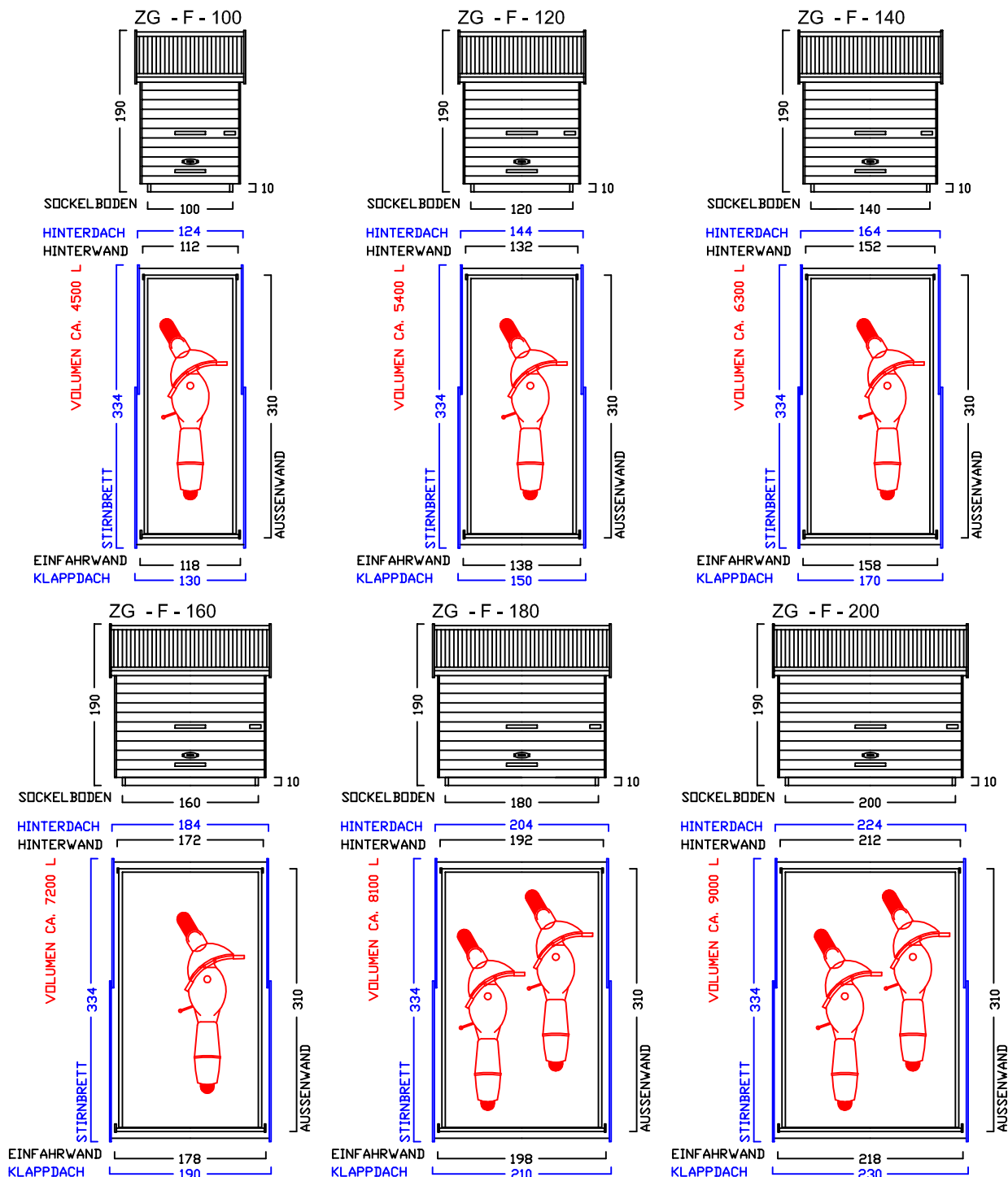
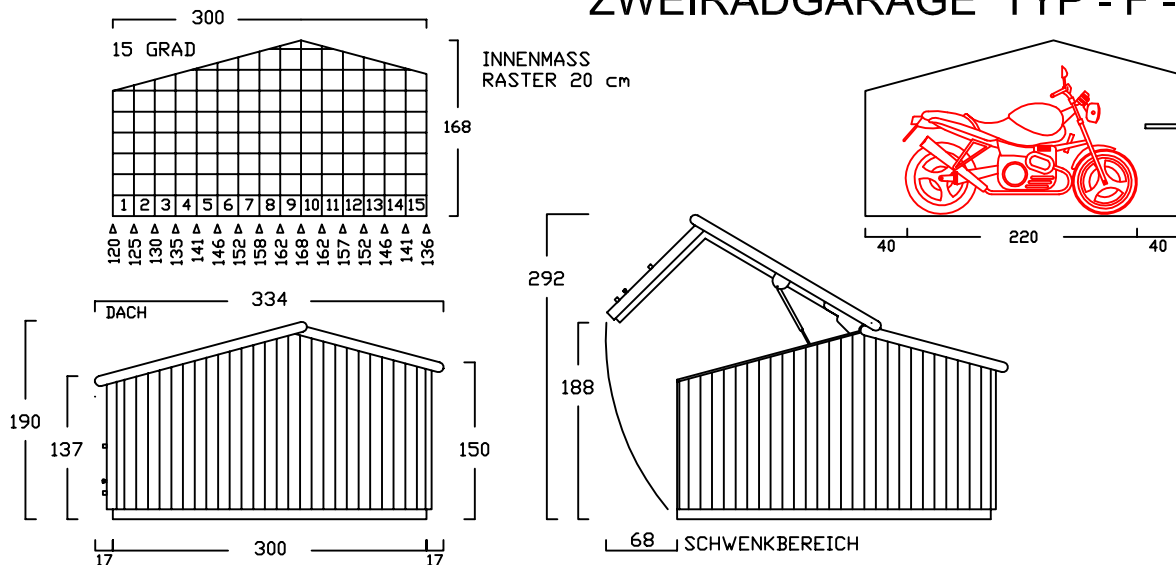





Die Typen ZG D sind hauptsächlich ausgelegt für Motorräder, Chopper- Motorräder (Tiefe) beträgt 260 cm

Typ	ZG D 100	ZG D 120	ZG D 140	ZG D 160	ZG D 180	ZG D 200
Innenmasse/Nutzfläche						
Länge / Breite	260 / 100 cm	260 / 120 cm	264 / 142 cm	260 / 160 cm	260 / 180 cm	260 / 200 cm
Volumen ca.	3700 l	4440 l	5180 l	5920 l	6660 l	7400 l
Seitenhöhe Innen	158 cm	158 cm	158 cm	158 cm	158 cm	158 cm
Komplettpreis; unbehandeltes Fichtenholz (ohne Sockelboden)	<b>1.710 €</b>	<b>1.810 €</b>	<b>1.910 €</b>	<b>2.010 €</b>	<b>2.110 €</b>	<b>2.210 €</b>
Sockelboden	160 €	180 €	200 €	220 €	240 €	260 €
Befestigungssatz (nur ohne Sockelboden notwendig)	140 €	140 €	140 €	150 €	150 €	150 €
Mehrpreis: Kesseldruckimprägniertes Fichtenholz	250 €	260 €	270 €	280 €	290 €	300 €
Mehrpreis: Lärchenholz	500 €	520 €	540 €	560 €	580 €	600 €
Knebelgriff mit intergriertem Schlosszylinder	inkl.	inkl.	inkl.	inkl.	inkl.	inkl.
Mehrpreis: Alu Stehfalzdach schwarz/anthrazit	230 €	250 €	270 €	290 €	310 €	330 €
Ablageboden 1 Stück	100 / 32 cm inkl.	120 / 32 cm inkl.	140 / 32 cm inkl.	160 / 32 cm inkl.	180 / 32 cm inkl.	200 / 32 cm inkl.
Lieferung (in Elementen)	210 €	210 €	210 €	240 €	240 €	240 €
Montage bis 300km (Umkreis HH-Billbrook)	auf Anfrage	auf Anfrage	auf Anfrage	auf Anfrage	auf Anfrage	auf Anfrage

Die Typen ZG E sind hauptsächlich ausgelegt für Motorräder, Chopper- Motorräder (Tiefe) beträgt 280 cm

Typ	ZG E 100	ZG E 120	ZG E 140	ZG E 160	ZG E 180	ZG E 200
Innenmasse/Nutzfläche						
Länge / Breite	280 / 100 cm	280 / 120 cm	280 / 140 cm	280 / 160 cm	280 / 180 cm	280 / 200 cm
Volumen ca.	4200 l	5040 l	5880 l	6720 l	7560 l	8400 l
Seitenhöhe Innen	168 cm	168 cm	168 cm	168 cm	168 cm	168 cm
Komplettpreis; unbehandeltes Fichtenholz (ohne Sockelboden)	<b>1.810 €</b>	<b>1.910 €</b>	<b>2.010 €</b>	<b>2.110 €</b>	<b>2.210 €</b>	<b>2.310 €</b>
Sockelboden	170 €	190 €	210 €	230 €	250 €	270 €
Befestigungssatz (nur ohne Sockelboden notwendig)	140 €	140 €	140 €	150 €	150 €	150 €
Mehrpreis: Kesseldruckimprägniertes Fichtenholz	260 €	270 €	280 €	290 €	300 €	310 €
Mehrpreis: Lärchenholz	520 €	540 €	560 €	580 €	600 €	620 €
Knebelgriff mit intergriertem Schlosszylinder	inkl.	inkl.	inkl.	inkl.	inkl.	inkl.
Mehrpreis: Alu Stehfalzdach schwarz/anthrazit	240 €	260 €	280 €	300 €	320 €	340 €
Ablageboden 1 Stück	100 / 32 cm inkl.	120 / 32 cm inkl.	140 / 32 cm inkl.	160 / 32 cm inkl.	180 / 32 cm inkl.	200 / 32 cm inkl.
Lieferung (in Elementen)	210 €	210 €	210 €	240 €	240 €	240 €
Montage bis 300km (Umkreis HH-Billbrook)	auf Anfrage	auf Anfrage	auf Anfrage	auf Anfrage	auf Anfrage	auf Anfrage

Die Typen ZG F sind hauptsächlich ausgelegt für Chopper- Motorräder (Tiefe) beträgt 300 cm

Typ	ZG F 100	ZG F 120	ZG F 140	ZG F 160	ZG F 180	ZG F 200
Innenmasse/Nutzfläche						
Länge / Breite	300 / 100 cm	300 / 120 cm	300 / 140 cm	300 / 160 cm	300 / 180 cm	300 / 200 cm
Volumen ca.	4500 l	5400 l	6300 l	7200 l	8100 l	9000 l
Seitenhöhe Innen	168 cm	168 cm	168 cm	168 cm	168 cm	168 cm
Komplettpreis; unbehandeltes Fichtenholz (ohne Sockelboden)	<b>1.910 €</b>	<b>2.010 €</b>	<b>2.110 €</b>	<b>2.210 €</b>	<b>2.310 €</b>	<b>2.420 €</b>
Sockelboden	180 €	200 €	220 €	240 €	260 €	270 €
Befestigungssatz (nur ohne Sockelboden notwendig)	140 €	140 €	140 €	150 €	150 €	150 €
Mehrpreis: Kesseldruckimprägniertes Fichtenholz	270 €	280 €	290 €	300 €	310 €	320 €
Mehrpreis: Lärchenholz	540 €	560 €	580 €	600 €	620 €	640 €
Knebelgriff mit intergriertem Schlosszylinder	inkl.	inkl.	inkl.	inkl.	inkl.	inkl.
Mehrpreis: Alu Stehfalzdach schwarz/anthrazit	250 €	270 €	290 €	310 €	330 €	350 €
Ablageboden 1 Stück	100 / 32 cm inkl.	120 / 32 cm inkl.	140 / 32 cm inkl.	160 / 32 cm inkl.	180 / 32 cm inkl.	200 / 32 cm inkl.
Lieferung (in Elementen)	210 €	210 €	210 €	240 €	240 €	240 €
Montage bis 300km (Umkreis HH-Billbrook)	auf Anfrage	auf Anfrage	auf Anfrage	auf Anfrage	auf Anfrage	auf Anfrage

Typ: gilt für die Breiten	ZG 100	ZG 120	ZG 140	ZG 160	ZG 180	ZG 200
Zubehör optional						
Profilylinderschloss für Schließanlage geeignet	110 €	110 €	110 €	110 €	110 €	110 €
zusätzlicher Ablageboden	30 €	30 €	30 €	35 €	35 €	35 €
Standard PVC-Trapezbedachung grau	inkl.	inkl.	inkl.	inkl.	inkl.	inkl.
PVC-Trapezbedachung grün oder rot	45 €	45 €	45 €	65 €	65 €	65 €
Auffahrrampe klein 80 cm breit	55 €	55 €	55 €	55 €	55 €	55 €
groß 100 cm breit	60 €	60 €	60 €	60 €	60 €	60 €
Bodenparker (Rund) für Fahrrad bis 55mm Radbreite	28 €	28 €	28 €	28 €	28 €	28 €
Bodenparker (Dreipunkt) für Fahrrad bis 55mm Radbreite	37 €	37 €	37 €	37 €	37 €	37 €
Montageschienen (2 Stück) für Bodenparker hauptsächlich für Montage ohne Sockelboden	29 €	29 €	29 €	37 €	37 €	37 €
Lasuren Fa. Remmers	AIDOL HK-Lasur 2,5L 55 € 5L 85 €		AIDOL Holzschutz Creme 2,5L 55 € 5L 90 €		AIDOL Pflegeöl 2,5L 50 € 5L 80 €	