

SICHTSCHUTZWÄNDE

120 LITER MÜLLTONNE

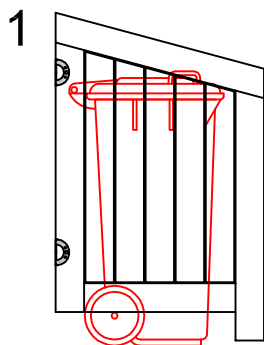

SSW 15 GRAD 70/110

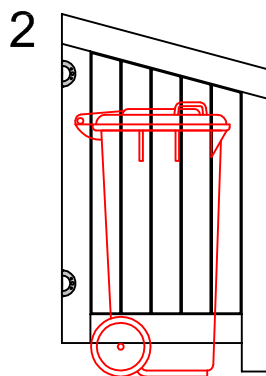

SSW 15 GRAD 70/120

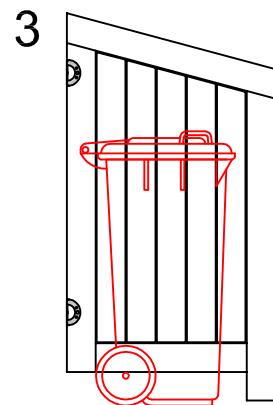

SSW 15 GRAD 70/130

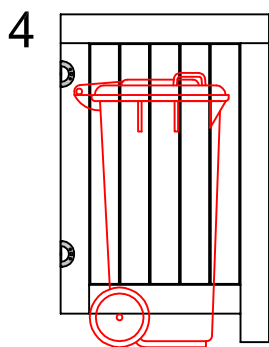

SSW 90 GRAD 70/110

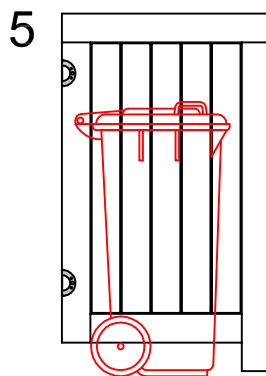

SSW 90 GRAD 70/120

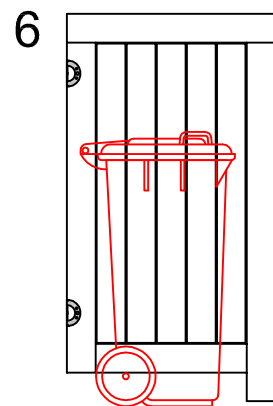

SSW 90 GRAD 70/130

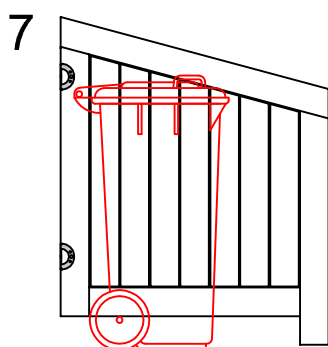

SSW 15 GRAD 90/110

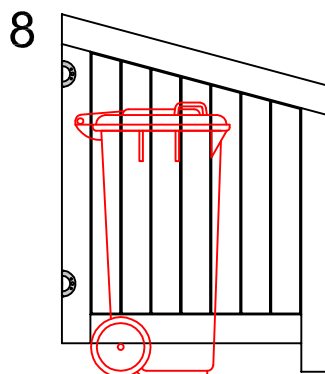

SSW 15 GRAD 90/120

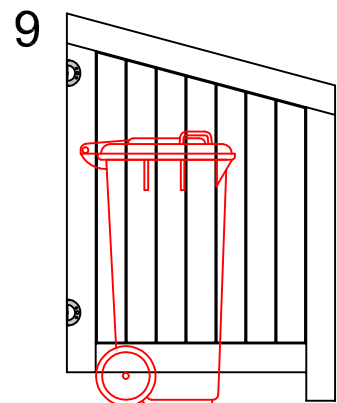

SSW 15 GRAD 90/130

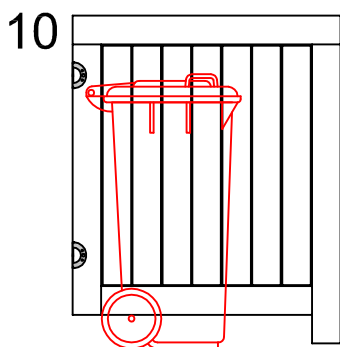

SSW 90 GRAD 90/110

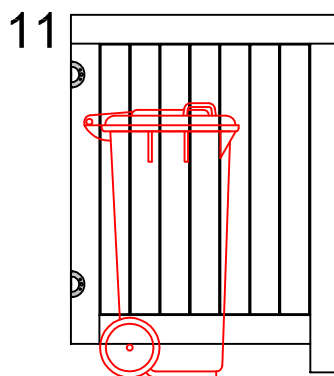

SSW 90 GRAD 90/120

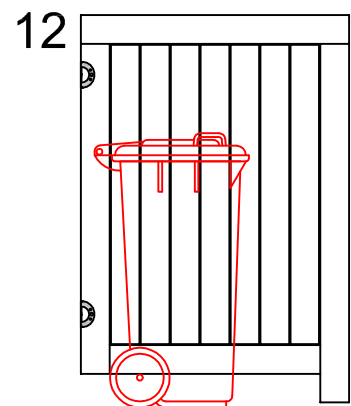

SSW 90 GRAD 90/130

SICHTSCHUTZWÄNDE (SSW) FÜR MÜLLTONNEN

ZG - A -

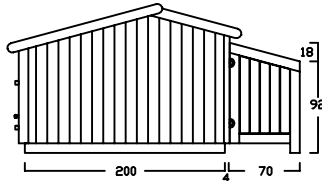

SSW 15 GRAD 70/110

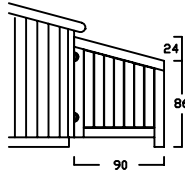

SSW 15 GRAD 90/110

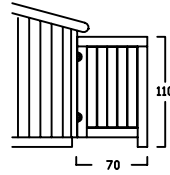

SSW 90 GRAD 70/110

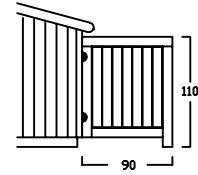

SSW 90 GRAD 90/110

ZG - B -

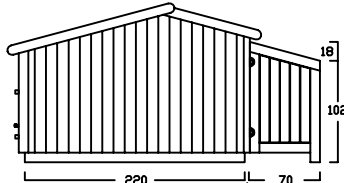

SSW 15 GRAD 70/120

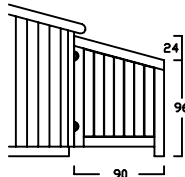

SSW 15 GRAD 90/120

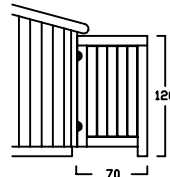

SSW 90 GRAD 70/120

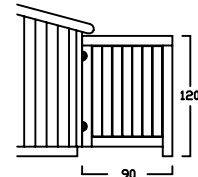

SSW 90 GRAD 90/120

ZG - C -

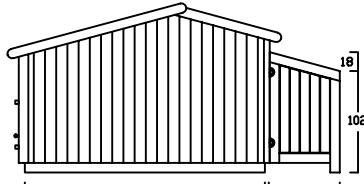

SSW 15 GRAD 70/120

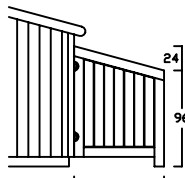

SSW 15 GRAD 90/120

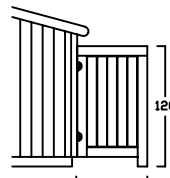

SSW 90 GRAD 70/120

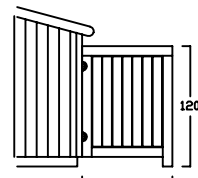

SSW 90 GRAD 90/120

ZG - D -

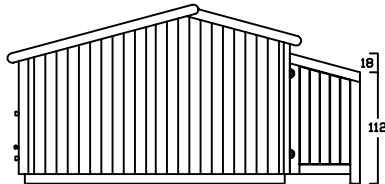

SSW 15 GRAD 70/130

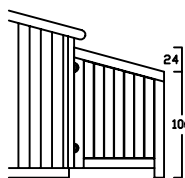

SSW 15 GRAD 90/130

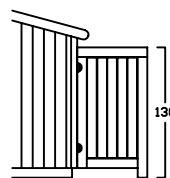

SSW 90 GRAD 70/130

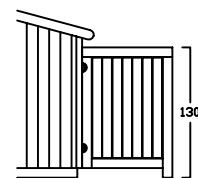

SSW 90 GRAD 90/130

ZG - E -

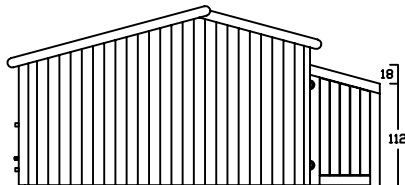

SSW 15 GRAD 70/130

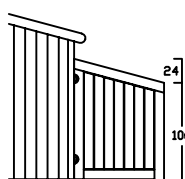

SSW 15 GRAD 90/130

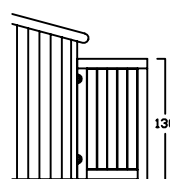

SSW 90 GRAD 70/130

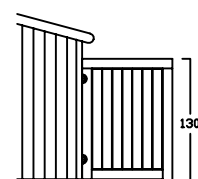

SSW 90 GRAD 90/130

ZG - F -

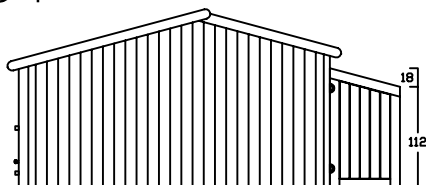

SSW 15 GRAD 70/130

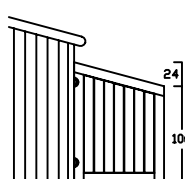

SSW 15 GRAD 90/130

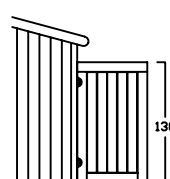

SSW 90 GRAD 70/130

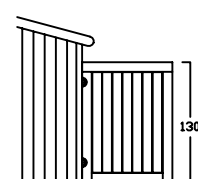

SSW 90 GRAD 90/130

SICHTSCHUTZWÄNDE (SSW) FÜR MÜLLTONNEN

ZG - A -

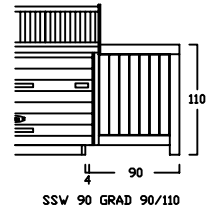
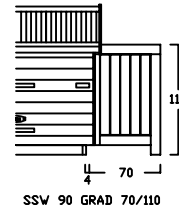
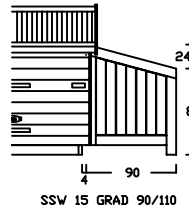
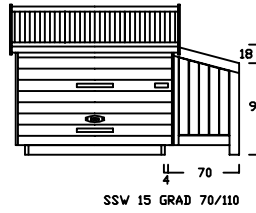
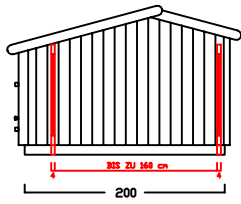

ZG - B -

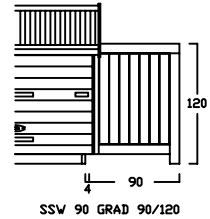
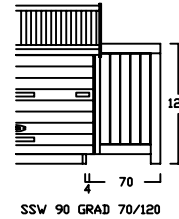
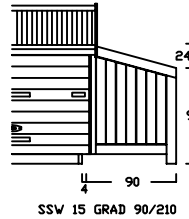
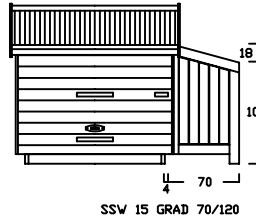
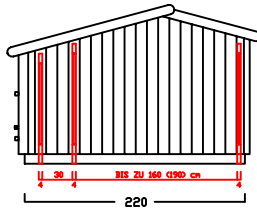

ZG - C -

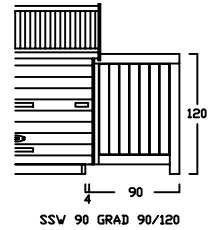
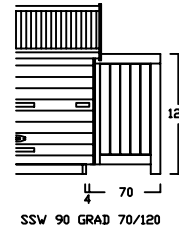
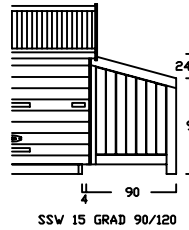
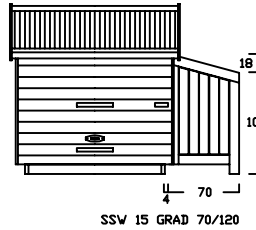
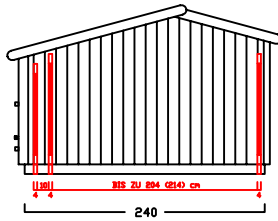

ZG - D -

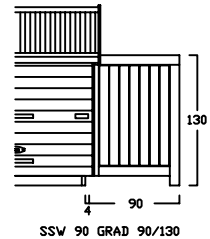
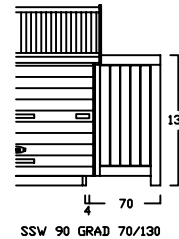
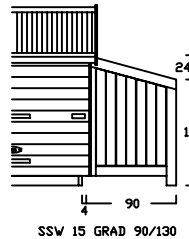
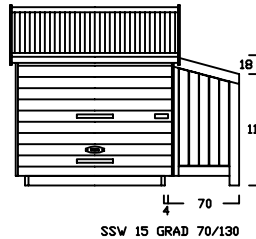
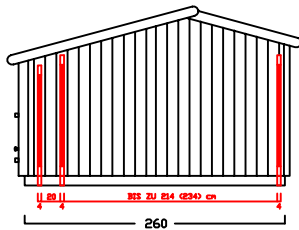

ZG - E -

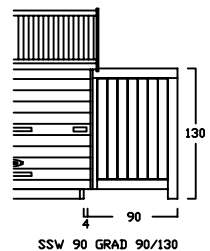
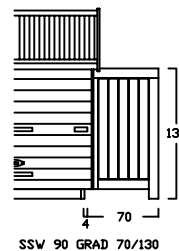
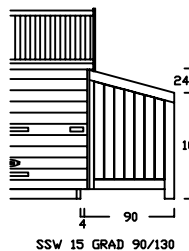
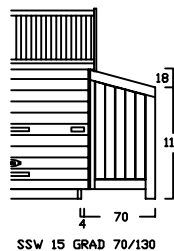
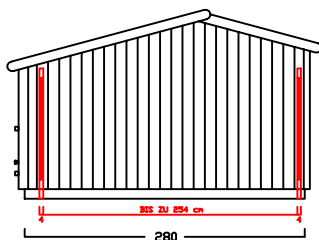

ZG - F -

