

# ZWEIRADGARAGE PLUS TYP - A - 140

VOLUMEN CA. 4620 L

INNENMASS RASTER 20 cm

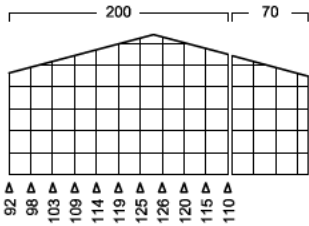

15 GRAD DACHNEIGUNG

FAHRRAD MIT  
LENKERHÖHE 110 cm

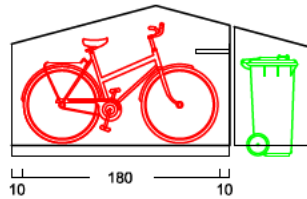

FAHRRAD MIT  
LENKERHÖHE 110 cm

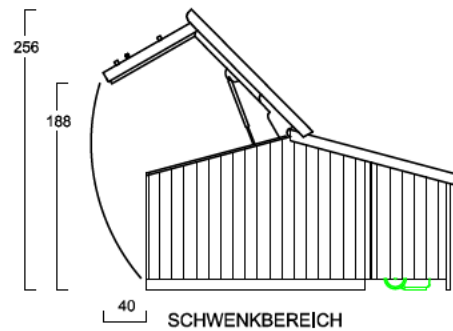
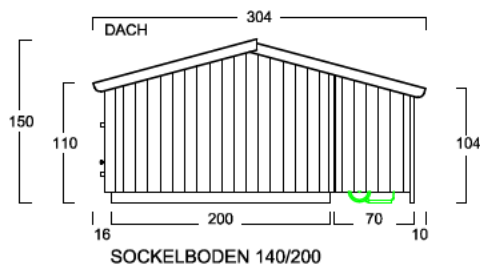
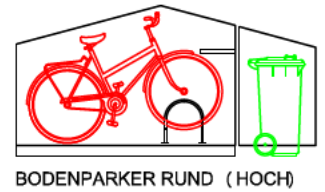

EINFAHRWAND / KLAPPDACH

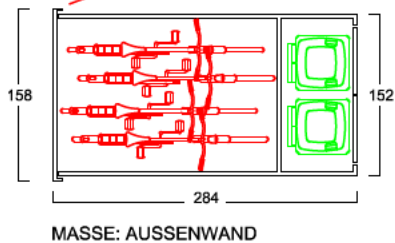

MASSE: AUSSENWAND

ANSICHT:  
EINFAHRT FAHRRÄDER  
KLAPPDACH

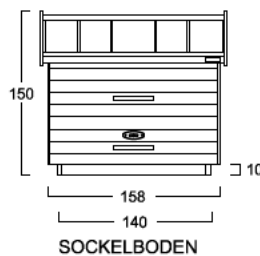

SOCKELBODEN

ANSICHT:  
BEREICH MÜLLGEFÄSE  
FLÜGELTÜREN

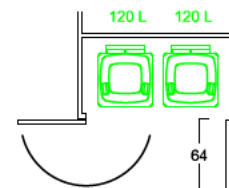
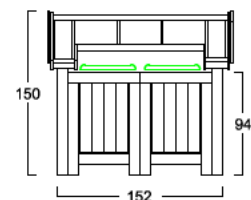

BEIDE TÜREN MIT 180 GRAD ÖFFNUNG

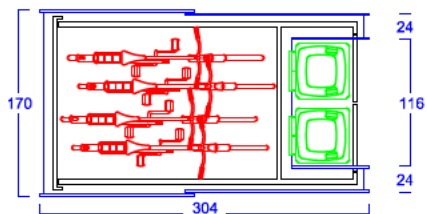

MASSE: DACH (STIRNBRETT)

Stauraum für 3 bis 4 Fahrräder  
und 2 Mülltonnen a. 120 Liter

www.zweiradgarage.de  
Fahrradgaragen Motorradgaragen  
Billbrookdeich 329 / 22113 Hamburg  
Tel.: 040 - 98 23 16 72  
Fax 040 - 98 23 16 73



info@zweiradgarage.de

pdf000010 13.02.18