

# ZWEIRADGARAGE PLUS TYP - A - 180

VOLUMEN CA. 5940 L

INNENMASS RASTER 20 cm

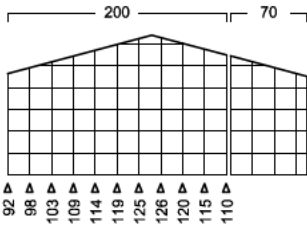

15 GRAD DACHNEIGUNG

FAHRRAD MIT  
LENKERHÖHE 110 cm

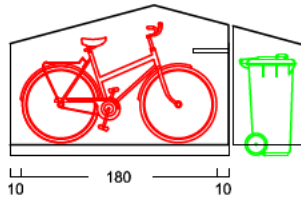

FAHRRAD MIT  
LENKERHÖHE 110 cm

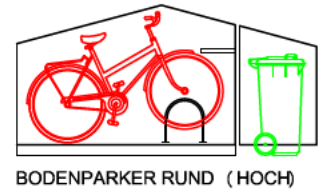

BODENPARKER RUND (HOCH)

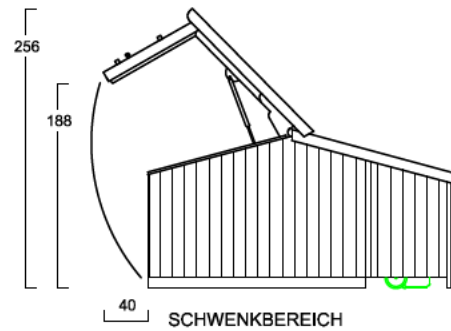
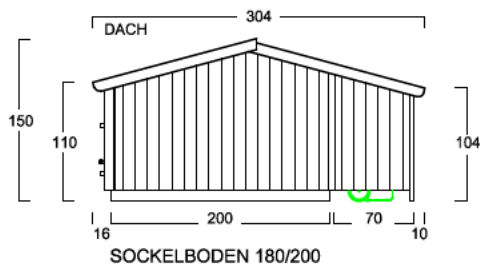

EINFABRHWAND / KLAPPDACH

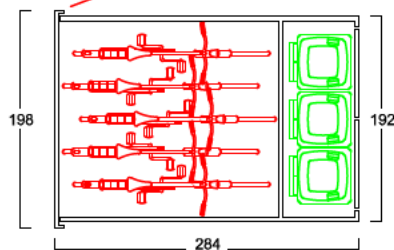

MASSE: AUSSENWAND

ANSICHT:  
EINFABRT FAHRRÄDER  
KLAPPDACH

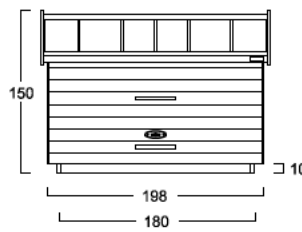

ANSICHT:  
BEREICH MÜLLGEFÄSE  
FLÜGELTÜREN

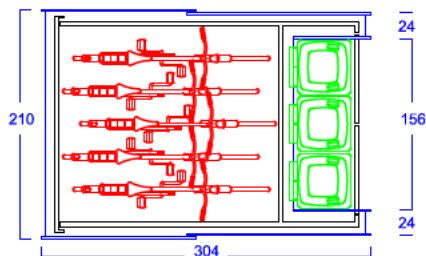
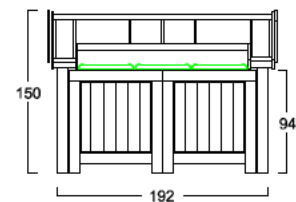

MASSE: DACH (STIRNBRETT)

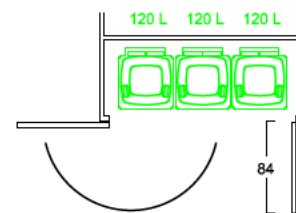

BEIDE TÜREN MIT 180 GRAD ÖFFNUNG

Stauraum für 5 bis 6 Fahrräder  
und 3 Mülltonnen a. 120 Liter

www.zweiradgarage.de  
Fahrradgaragen Motorradgaragen  
Billbrookdeich 329 / 22113 Hamburg  
Tel.: 040 - 98 23 16 72  
Fax 040 - 98 23 16 73



info@zweiradgarage.de

pdf000012 13.02.18