

ZWEIRADGARAGE FÜR ZWEI E-BIKES

INNENMASS

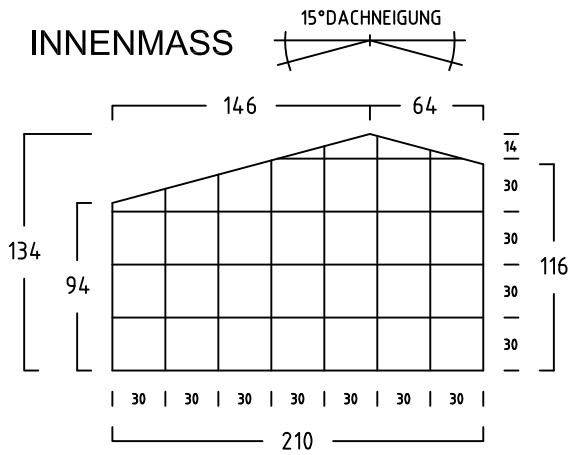

FAHRRAD MIT LENKERHÖHE 110 cm

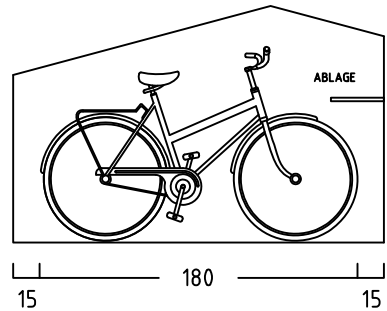

- RECHTE SEITENWAND -

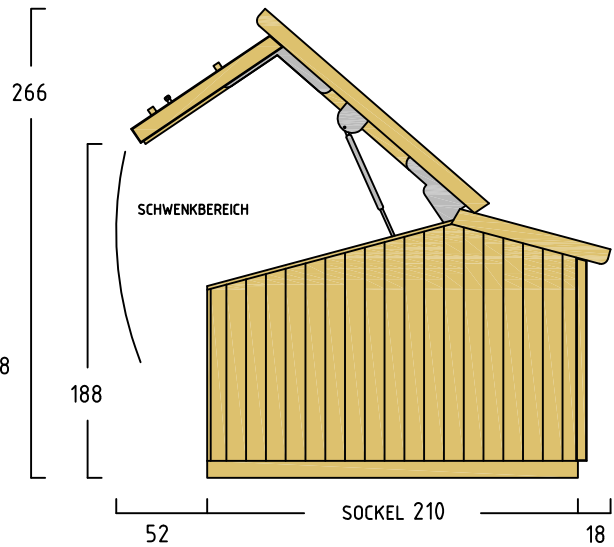
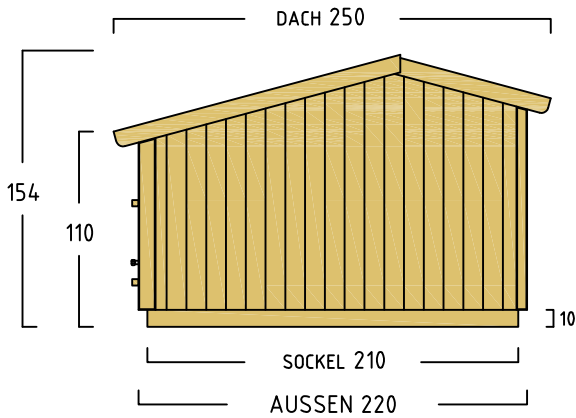

- GRUNDRISS -

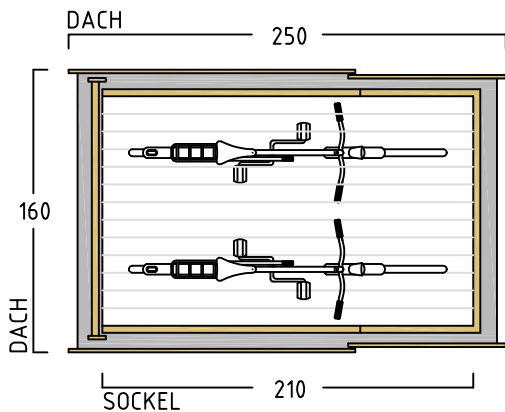

- EINFABRWAND -

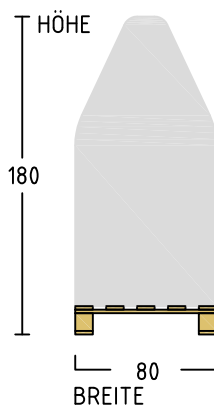
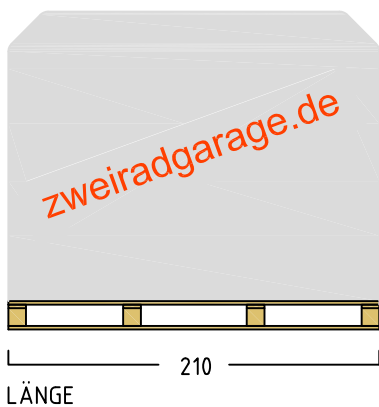
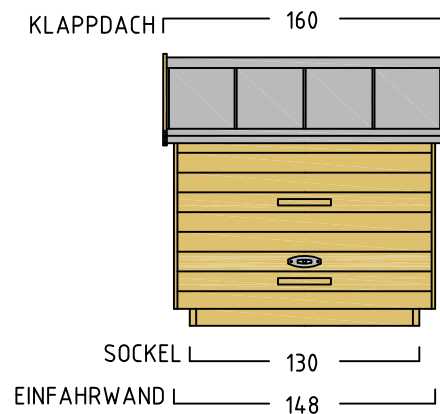

- VERPACKUNG -

ZWEIRADGARAGE
IN 7 VORMONTIERTEN ELEMENTEN
VERPACKT AUF EINWEGPALETTE
GES. GEWICHT CA. 200 KG